

ConneXium

Ethernet Cabling System

Quick Reference Guide

Electrical Switch 10/100 Mbps 7TX 499NES17100
Optical Switch 10/100 Mbps 5TX/2FX 499NOS17100

Version 3.0

31005848 00



Telemecanique

Safety Information

Notice

Read these instructions carefully, and look at the equipment to become familiar with the device before trying to install, operate, or maintain it. The following special messages may appear throughout this documentation or on the equipment to warn of potential hazards or to call attention to information that clarifies or simplifies a procedure.



The addition of this symbol to a Danger or Warning safety label indicates that an electrical hazard exists, which will result in personal injury if the instructions are not followed.



This is the safety alert symbol. It is used to alert you to potential personal injury hazards. Obey all safety messages that follow this symbol to avoid possible injury or death.



DANGER

DANGER indicates an imminently hazardous situation, which, if not avoided, **will result** in death, serious injury, or equipment damage.



WARNING

WARNING indicates a potentially hazardous situation, which, if not avoided, **can result** in death, serious injury, or equipment damage.



CAUTION

CAUTION indicates a potentially hazardous situation, which, if not avoided, **can result** in injury or equipment damage.

Please Note

Electrical equipment should be serviced only by qualified personnel. No responsibility is assumed by Schneider Electric for any consequences arising out of the use of this material. This document is not intended as an instruction manual for untrained persons.

© 2004 Schneider Electric. All Rights Reserved.

ConneXium Ethernet Cabling System Quick Reference Guide

Overview

The ConneXium family of hubs, switches, transceivers, and gateways is especially designed for industrial environments.

This Quick Reference contains information essential to getting up and running quickly with the following two switches:

- ConneXium Switch 10/100 Mbps 5TX/2FX
- ConneXium Switch 10/100 Mbps 7TX for ISO/DIN Rail

The ConneXium NxS manageable Fast Ethernet switch provides five connections for terminal equipment or other network segments. These ConneXium switches also provide two 100 Mbps backbone connections (fiber optic or twisted-pair), a standby port, and a V.24 interface (RJ-11) for local switch management and configuration. More detailed information on the design, installation, and operation of the ConneXium NxS switch is available on the enclosed CD-ROM.

What's in this Chapter?

This chapter contains the following topics:

Topic	Page
Introduction	1
Functional Description	4
Configuration	7
Assembly, Startup Procedure and Dismantling	10
ConneXium Ethernet Cabling System Technical data	12

Introduction

The ConneXium NxS Switch

The internal switch control intelligence of a ConneXium NxS permits the redundant coupling of several network segments to a higher network segment.

The switch learns up to 2000 addresses, allowing the connection of several independent subnetworks. When reset, the switch deletes the learned addresses. Link integrity of all ports is assured through link testing in accordance with IEEE 802.3. Additionally, if the receive cable pair signals are incorrectly connected (if RD+ and RD- are switched), the NxS automatically detects it and reverses the connection polarity. The ConneXium NxS switch uses shielded RJ-45 connectors that are internally wired in the accordance with the MDI-X specification.

**Staff
Qualification
Requirements**

Only appropriately qualified staff should work on or near this equipment. Such staff must be thoroughly acquainted with all the warnings and maintenance measures contained in these operating instructions.

The proper and safe operation of this equipment assumes proper transport, appropriate storage and assembly, and careful operation and maintenance. Qualified staff, within the meaning of these operating instructions or the warning notes, are persons familiar with setting up, assembling, starting up, and operating this product and who have appropriate qualifications to cover their activities, such as:

- training or instruction/entitlement to switch circuits and equipment/systems on and off, ground them, and identify them in accordance with current safety standards;
- training or instruction in accordance with current safety standards in looking after and using appropriate safety equipment;
- first aid training.

**Installation and
Security
Instructions**

	CAUTION
	<p>Possible injury or equipment damage.</p> <p>Electricity is used to operate this equipment. Comply in every detail with the safety requirements specified in the operating instructions regarding the voltages to apply!</p> <p>Failure to follow this precaution can result in injury or equipment damage.</p>

	WARNING
	<p>Possible injuries or material damage.</p> <p>If warning notes are ignored, severe injuries and/or material damage may occur.</p> <p>Failure to follow this precaution can result in death, serious injury, or equipment damage.</p>

	WARNING
	<p>Possible material damage.</p> <p>The ConneXium Switches 10/100 Mbps 5TX/2FL or 7TX units are designed for operation with safety extra-low voltage. Accordingly, only safety extra-low voltages (SELV) conforming to IEC950/EN60950/VDE0805 may be connected to the supply voltage connections.</p> <p>Failure to follow this precaution can result in death, serious injury, or equipment damage.</p>

Hardware

The following figure describes the interfaces, display elements, and controls of the ConneXium Switch 10/100 Mbps 5TX/2FX (499NOS17100).

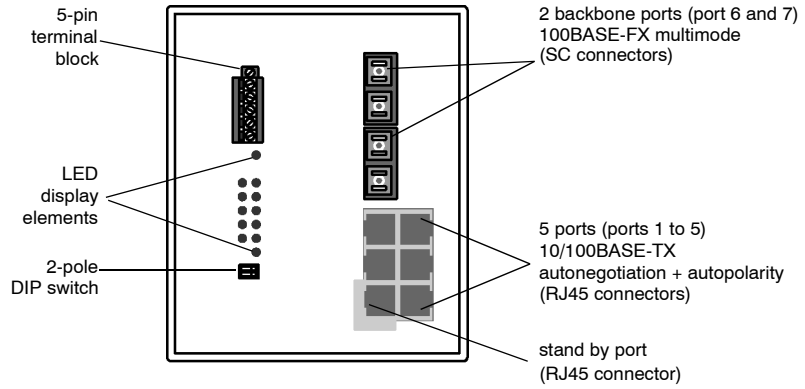

The following figure describes the interfaces, display elements, and controls of the ConneXium Switch 10/100 Mbps 7TX (499NES17100).

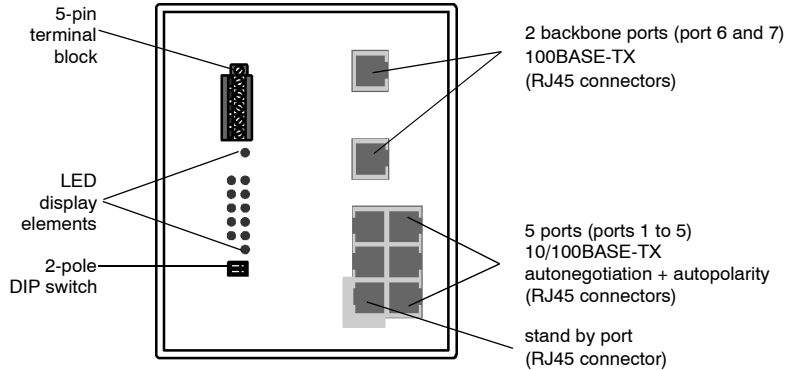

Functional Description

Overview

The ConneXium NxS manageable Fast Ethernet switch provides five connections for terminal equipment or other network segments. ConneXium switches also provide two 100 Mbps backbone connections (fiber optic or twisted-pair), a standby port, and a V.24 interface (RJ-11) for local switch management and configuration. The internal switch control intelligence permits the redundant coupling of several network segments to a higher network segment.

The ConneXium NxS switch learns up to 2000 addresses, allowing several independent subnetworks to be connected to it. When the ConneXium NxS switch is reset, it deletes the learned addresses.

Link integrity of all ports is assured through link testing in accordance with IEEE 802.3. Additionally, if the receive cable pair signals are incorrectly connected (if RD+ and RD- are switched), the NxS automatically detects this and reverses the connection polarity. All ConneXium NxS switch RJ-45 connectors (including the Standby connector) are shielded. The connectors are internally wired in accordance with the MDI-X specification. The Standby Port output pins (3 and 6) are electrically isolated from the operating voltage and the chassis. Communication Ports 1–5 are factory set with auto-negotiate active. Communication Ports 6–7 are factory set to 100 Mbps and Full Duplex operation. The ConneXium NES switch Ports 6–7 will also support auto-negotiation and auto-polarity.

More detailed information on the design, installation, and operation of the ConneXium NxS switch is available on the enclosed CD-ROM.

Resetting the NxS Switch

Reset: The NxS will be reset by the following actions:

- activating the RM and Standby DIP switches simultaneously
- management
- input voltage falls below a tag
- watchdog

After a reset, the following actions are carried through:

- self test
 - initialization
-

**V.24 Interface
(External
Management)**

A serial interface for local connection of an external management station (VT100 terminal or a PC with corresponding terminal emulation) is available on the RJ11 socket (V.24 interface). A link can thus be established with the User Interface UI VT-100 terminal settings:

- Speed: 9600 Baud
- Data: 8 bit
- Stop bit: 1 bit
- Handshake: off
- Parity: none

The V.24 interface supports baud rates of 9600 and 19200. System start-up default setting is 9600 Baud.

The following figure describes the pin configuration of the V.24 interface.

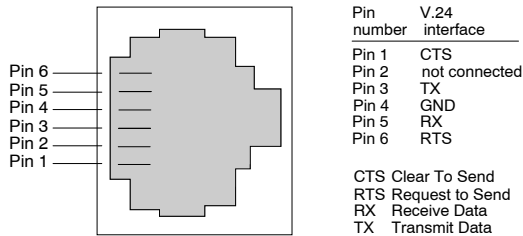

The socket casing is electrically connected to the front panel of the device.

Note: The TF Switch configuration cord (490NTRJ11) must be used with a V.24 connection.

Note: Once a link has been established, data cannot be transmitted by way of the console while the modem or Telnet is using the UI. Entering the exit command by way of the telnet link frees the UI.

5-Pin Terminal Block

The supply voltage and the indicator contact are connected via a 5-pin terminal block with screw locking mechanism.

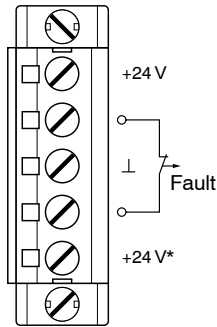

	WARNING
	<p>Potential injury or equipment damage due to excessive voltage.</p> <p>The NxS equipment is designed for operation with SELV. Only safety extra-low voltages to IEC950/EN60950/VDE0805 may be connected to the supply voltage connections and to the indicator contact.</p> <p>Failure to follow this precaution can result in death, serious injury, or equipment damage.</p>

Voltage supply: The voltage supply can be connected to be redundant. Both inputs are decoupled. There is no load distribution. With redundant supply, the power pack supplies the NxS alone with the higher output voltage. The supply voltage is electrically isolated from the housing.

Indicator contact: The indicator contact is used to monitor the functions of the NxS and thus facilitates remote diagnostics.

When a potential-free indicator contact (relay contact, closed circuit) opens, one of the following is indicated:

- the failure of at least one of the two supply voltages
- a permanent fault in the NxS (internal 3,3 V DC voltage, supply voltage 1 or 2 < 18 V, ...)
- the faulty link status of at least one port (The indication of the link status on the NxS might be masked on a port-by-port basis using the management software.)
- self test error

The NxS modules in standby mode indicate the following states:

- interrupted control line
- short-circuited control line
- partner device runs in standby mode

The NxS modules in normal mode indicate the following states:

- short-circuited control line
- partner device runs in normal mode

The NxS modules in RM mode indicate the following state:

- Ring monitoring is not possible, e.g. during software initializing.

Note: In the case of the voltage supply being routed without redundancy, the NxS indicates the failure of a supply voltage. You can prevent this message by feeding in the supply voltage through both inputs.

Ground connection: The NxS modules are grounded via a separate screw connection.

Configuration

Line Structure

The NxS switches enable backbones in line structures to be built up. Cascading is carried out using the backbone ports (see the figure below, "optical line structure").

Redundant Ring Structure

With the redundancy manager function of the NxS modules you can close the two ends of a line structured backbone to a redundant ring (see the figures below, "redundant optical ring" and "redundant copper ring"). The NxS switches are integrated into the ring via the backbone ports (ports 6 and 7). If one section fails the reaction time comes to less than 0.5 seconds at up to 50 NxS modules being cascaded.

Redundant Coupling of Network Segments

The built-in control intelligence of the NxS allows the redundant coupling of network segments (see the figure below, "redundant coupling of optical rings").

The connection of two network segments is realized via two separate paths. The NxS switches in the redundant line get the redundancy function assigned by the DIP switch setting standby.

The NxS modules in the redundant line and the NxS switches in the main line share their operating states via the control line (cross over ETHERNET cable).

After the failure of the main line the redundant NxS modules enable the redundant line within 0.5 seconds. If the main line is okay again, the NxS switches in the main line inform the redundant Nxs modules about this. The main line will be enabled and the redundant line will be disabled within 0.5 seconds.

The following figure describes an Optical Line Structure.

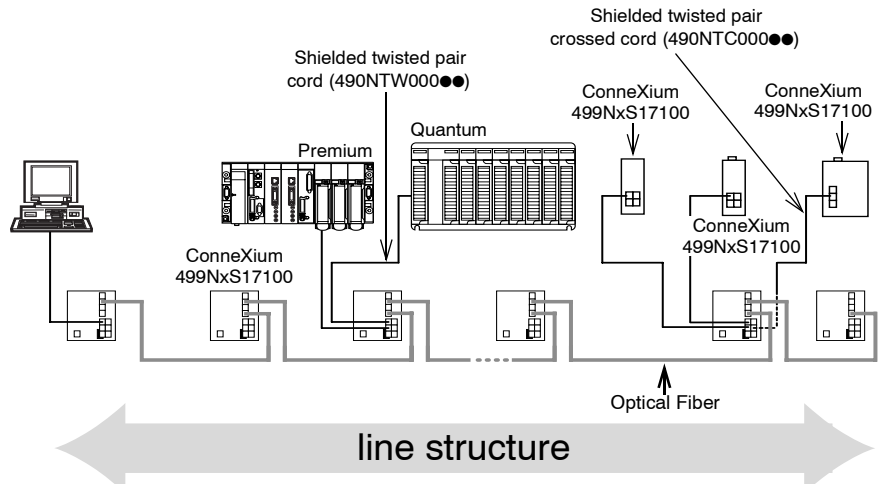

The following figure describes a Redundant Ring Structure.

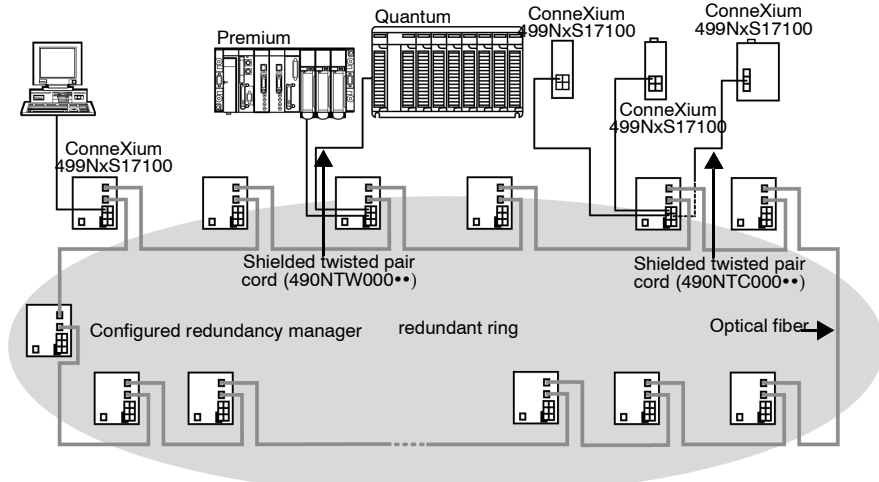

The following figure describes a Redundant Coupling of Optical Rings structure.

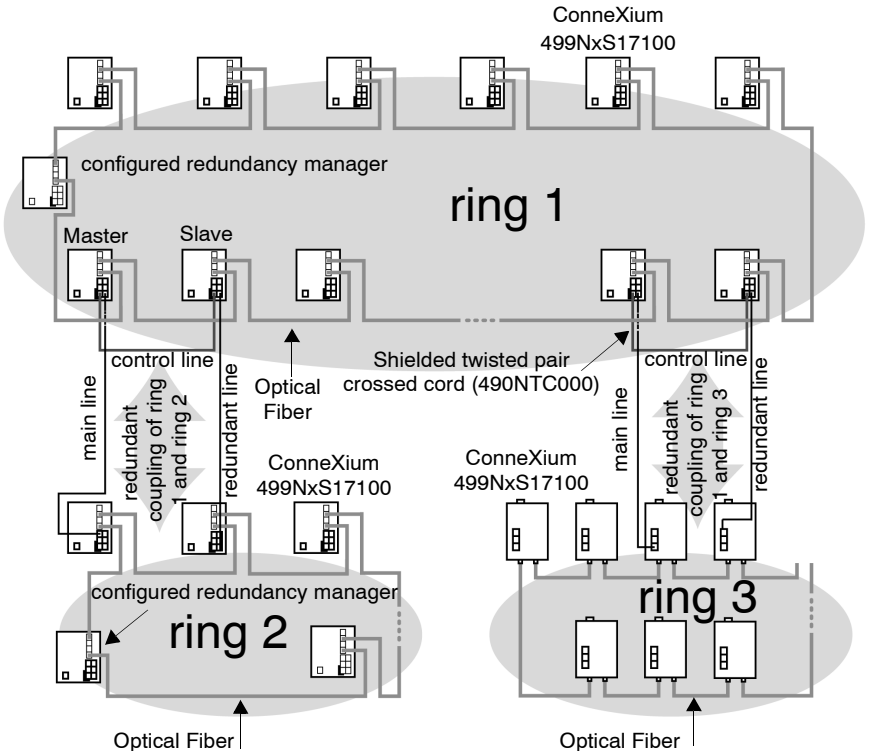

Assembly, Startup Procedure and Dismantling

Unpacking, Checking

Check whether the package was delivered complete (see scope of delivery).
Check the individual parts for transport damage.

	WARNING
	<p>Potential injury or harm to equipment due to use of damaged parts.</p> <p>Use only undamaged parts!</p> <p>Failure to follow this precaution can result in death, serious injury, or equipment damage.</p>

Assembly

The equipment is delivered in a ready-to-operate condition. The following procedure is appropriate for assembly.

Step	Action
1	Check whether the switch factory-setting is suitable for your requirements (see Controls, above).
2	Pull the terminal block off the NxS and wire up the supply voltage and indicator lines.
3	Fit the NxS on a 35 mm standard bar to DIN EN 50 022.
4	Suspend the upper snap-on slide bar of the NxS in the standard bar and press it down towards the standard bar until it locks in position.
5	Fit the signal lines and if required the control line.
6	Always connect the main line and the redundant line to port 1 of the NxS for the redundant coupling of ring structures.

Additional Considerations

- The front panel of the NxS is grounded via a separate ground connection.
- Do not open the housing.
- The shielding ground of the twisted pair lines which can be connected is electrically connected to the front panel.

The following figure describes the assembly of the NxS.

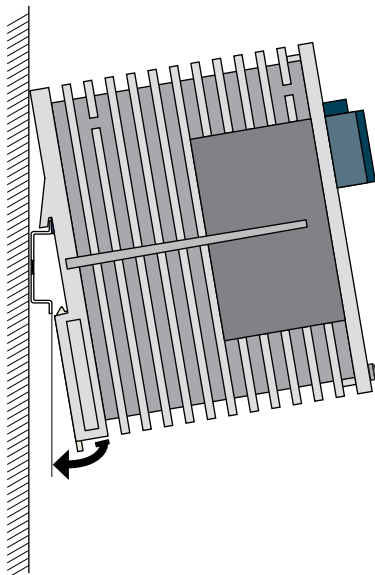

Startup Procedure

You start up the NxS by connecting the supply voltage via the 5-pin terminal block. Lock the terminal block with the locking screw at the side.

Dismantling

To take the NxS off the ISO/DIN rail, insert a screwdriver horizontally under the housing into the locking slide, pull it (without tipping the screwdriver) downwards and tilt the NxS upwards.

ConneXium Ethernet Cabling System Technical data

Overview

The following table contains technical data for the ConneXium Ethernet Cabling System.

Operating Voltage	DC 24 V -25% +33% safety extra-low voltage (SELV) (redundant inputs decoupled)
Current Consumption	0.8 A maximum, at 24 VDC
Overload Current Protection at Input	Non-replaceable thermal fuse
Dimensions W x H x D	110 mm x 131 mm x 111 mm / 4.3 in x 5.2 in x 4.4 in
Weight	850 g / 1.87 lb.
Temperature (Ambient/ Storage)	0° C to + 55° C / 20° C to 80° C
Humidity	10% to 95% (not-condensing)
Laser Protection	Class 1 conforms to EN 60825
Protection Class	IP 20
Interference Immunity	EN 61000-4-2 Level 3, -3 Level 3, 4 Level 3, -5, -6 Level 3
Mechanical (Shock/ Vibration)	IEC 60068-2-27 Test Ea / -6 Test Fc
Radio Interference Level	
Conducted Emission	EN 55022 Class B
Radiated Emission	EN 55022 Class A, CFR-47 Part 15 Class A
Agency Approvals	cUL 1950, UL 508, CSA 22-2.142, CSA 22-2.213 Class 1 Div 2, CE, FM, IEC 61131-2 Marine (Germanischer Lloyd)
Mounting Clearance	Side to side: 0.0 cm/in Top to bottom: 10.0 cm/3.94 in

	WARNING
	<p>Possible injury or damage if cables are connected in a hazardous atmosphere.</p> <p>Do not connect or disconnect cables while a hazardous atmosphere is present.</p> <p>Failure to follow this precaution can result in death, serious injury, or equipment damage.</p>

	WARNING
	<p>RF Warning</p> <p>This is a Class A Equipment. This equipment may cause radio interference if used in a residential area; in this case it is the operator's responsibility to take appropriate measures.</p> <p>Failure to follow this precaution can result in death, serious injury, or equipment damage.</p>

Network Size

The following table contains network size data for the ConneXium Ethernet cabling System.

Control line	
For the redundant coupling of rings	< 10 Ohm (back and forth direction together)
Maximum Segment Length	
10BASE-T	100 m (328 ft.) maximum
100BASE-TX	100 m (328 ft.) maximum
F/O line length (example)	
50/125 μm fiber (multimode)	3000 m (9843 ft.) maximum (data of fiber: 1.6 dB/km, 500 Mhz*km)
62.5/125 μm fiber (multimode)	3000 m (9843 ft.) maximum (data of fiber: 1.6 dB/km, 500 Mhz*km)
F/O port 100BASE-FX (NxS)	
According to IEEE 802.3u 100BASE-FX	
System attenuation	
50/125 μm fiber (multimode)	8 dB (TF Switches 10/100 Mbps 5TX/2FX or 7TX)
62.5/125 μm fiber (multimode)	11 dB (TF Switches 10/100 Mbps 5TX/2FX or 7TX)
Wave length	1300 nm
Interfaces	
NxS Modules	5 TX ports (RJ45 sockets, 10/100 Mbps) V.24 port external management Standby port, (RJ45 Socket)
in addition on NxS Modules 2 backbone ports each	
NxS Module	2 TX ports (RJ45 sockets, 10/100 Mbps)
NxS Module	2 FX ports (SC sockets, multimode, 100 Mbps)
Indicator contact	1 A maximum, 24 V

Displays

The following table contains display data for the ConneXium Ethernet cabling System.

Displays		
Equipment status	Lit	not Lit
P1 - Power 1 (green)	Supply voltage 1 present	Supply voltage 1 is less than 18 V
P1 - Power 2 (green)	Supply voltage 2 present	Supply voltage 2 is less than 18 V
FAULT - Error (red)	Fault contact open (Error)	Fault contact closed (No Error)
Standby (green)	Standby function enabled	Standby function disabled
RM - Redundancy Manager (green/yellow)	green: RM function active, redundant port inactive yellow: RM function active, redundant port active	RM function not active
Port 1–7	Green/Yellow LED)	Data, Link status
	Not lit	No valid connection
	Green	Valid connection
	Blinks green (once a period)	Port is switched to standby (Port 1)
	Blinks green (three times a period)	Port is disabled
	Blinks yellow	Data reception
	Blinking in sequence	Initialization phase after reset
Controls		
DIP switch (2 pole)	RM (Factory set = OFF)	Activate redundancy manager function
	Standby (Factory set = OFF)	Activate standby function
Scope of delivery		
NxS Modules include	Terminal block for supply voltage	
	Quick Reference Guide	
	NxS Module Documentation Configuration Software	
Order Numbers	5TX/2FX	499 NOS 171 00
	7TX	499 NES 171 00

Accessories

The following table lists available accessories relating to NxS switches.

Accessories	
TF Ethernet STP cat5 RJ-45 cords	490 NTW 000 xx
TF Ethernet STP cat5 RJ-45 crossed cords	490 NTC 000 xx
TF Switch configuration cord	490 NTRJ 11
ConneXium Ethernet Cabling System Switch Management Manual (Version 4.0)	31005844

CE Information on the NxS Modules



The devices comply with the regulations of the following European directive:

89/336/EEC Council Directive on the harmonization of the legal regulations of member states on electromagnetic compatibility (amended by Directives 91/263/EEC, 92/31/EEC and 93/68/EEC).

The product can be used in the industrial sphere (business and trade sphere and small companies).

The precondition for compliance with EMC limit values is strict adherence to the construction guidelines specified in this description and operating instructions.

The following table provides additional CE testing information.

Area Used	Requirements for emitted interference	Interference immunity
Industrial	EN 50081: 1993 EN 55022 Class A: 1998	EN 61000-6-2: 1999



* 3 1 0 0 5 8 4 8 * 00

Visit <http://www.schneider-electric.com> for your nearest Schneider Electric affiliate.

Printed in France